

# **Level 3 Advanced Technical Diploma in Bricklaying (450)**

**(7905-30)**

**Version 1.1**

## **Practice Tasks**

# Introduction

General information about structure of the practice tasks

Learner section

- Practice tasks guidance
- Completion of tasks
- Tasks

Assessor section

- Assessor guidance
- Guidance on tasks
- Knowledge question answer keys
- Appendix
- Declaration of Authenticity
- Feedback form

Appendix

## Practice Tasks 7905-30

### General guidance

This is a formative assessment that you will complete. You will be observed and feedback will be given. You will be marked on the quality and accuracy of your practical performance and any written work you produce. It is therefore important that you carry your work out to the highest standard you can. You should show how well you know and understand the subject and how you are able to use your knowledge and skills together to complete the tasks.

### Health and Safety

You must always work safely, in particular while you are carrying out practical tasks.

You must always follow any relevant Health and Safety regulations and codes of practice.

If your tutor sees you working in a way that is unsafe for yourself or others, they will ask you to stop immediately, and tell you why. Your tutor will not be able to reassess you until they are sure you are ready to work safely.

### Presentation of work

Presentation of work must be neat and appropriate to the task.

You should make sure that each piece of work is clearly labelled with your name and the task title.

Any electronic files must be given a clear file name that allows your tutor to identify them as your work.

## Completion of tasks

You will be required to read the job details and use the candidate instructions for each practice task to produce the end product. You will be required to answer three multiple choice questions related to the tasks.

Your completed piece of work will be marked against the standards set out in the candidate instructions table within each practice task. Your tutor will mark the multiple choice questions and give you feedback.

Your tutor will provide constructive feedback, highlighting areas of both good practice and areas requiring development.

Your performance will be observed throughout the task, and any help or guidance provided by your tutor or peers will be taken into consideration on the marking of your completed work.

## Tasks

**Task 1** Remove and replace a defective lintel over a door opening

<b>Candidate name</b>	
<b>Date</b>	

**Job details:** provide temporary supports to allow the removal of a defective lintel, remove the defective lintel, clean and prepare the bearing points. Bed the new lintel in place and fill the joint between the masonry and the new lintel, make good around the area.

**Assessment methods:** this task requires you to demonstrate your practical skills in preparing the work area and carrying out the removal of defective materials and the replacement of them with new ones. You will be assessed by observation throughout the task and on the final outcome.

**Scope of content:**

- select tools, equipment and materials
- prepare and carry out the replacement of a defective lintel in a safe manner and using the correct methods and equipment.

No.	Candidate instructions	Achieved	
		Yes	No
1	Select tools, equipment and materials to carry out the work. i. On the answer sheet provided sketch or insert images of the tools, equipment and materials that you will need to carry out the work.		
2	Prepare the work area and provide barriers. i. On the answer sheet provided sketch or insert images of the tools, equipment and materials that you will need to carry out the work.		
3	Explain how the props should be positioned and provide temporary support and position props. i. On the answer sheet provided explain how you will support the brickwork over the opening to allow you to remove the existing lintel.		
4	Remove the defective lintel and prepare the bearings.		
5	Position the new lintel and pack and fill the joint.		
6	Remove the temporary support and make good the joint.		
7	Housekeeping <ul style="list-style-type: none"> <li>• Leave work area clean and tidy.</li> <li>• Clean the area and replace tools and surplus resources.</li> <li>• Dispose of waste correctly (if applicable).</li> </ul>		

**Candidate answer sheet**

1i and 2i provide sketches or insert images of the **tools, equipment** and **materials** that you will need to carry out the work.

3i explain how you will support the brickwork over the opening to allow you to remove the existing lintel.

.....

.....

.....

.....

.....

.....

.....

## Knowledge questions

1) What is the **minimum** bearing for a concrete lintel?

- a. 75 mm
- b. 100 mm
- c. 150 mm
- d. 200 mm

2) What is the **minimum** bearing for a metal lintel?

- a. 75 mm
- b. 100 mm
- c. 150 mm
- d. 200 mm

3) Which tool should be used to remove a bed joint when fitting a strongboy in position?

- a. Bolster chisel.
- b. Cold chisel.
- c. Plugging chisel.
- d. Comb chisel.



<b>Task title:</b>	Remove and replace a defective lintel over a door opening
--------------------	---

<b>Candidate feedback</b>
---------------------------

--

<b>Assessor feedback</b>
--------------------------

--

<b>Action plan</b>
--------------------

--

**Task 2** Remove a spalled brick from a wall and replace with a new one

<b>Candidate name</b>	
<b>Date</b>	

**Job details:** remove a spalled brick from a wall and replace it with a new brick and mortar to match the existing wall.

**Assessment methods:** you will be assessed on the way in which you identify the replacement brick and how you select the materials for the mortar. You will also be assessed on the way in which you carry out the removal and repair to ensure minimal damage and a good match to the existing wall. You will be assessed by observation throughout the task and on the final outcome.

**Scope of content:**

- select materials, tools and equipment
- match existing brick and mortar.

No	Candidate instructions	Achieved	
		Yes	No
1	Select the <b>correct</b> tools, materials and equipment to carry out the task.		
2	Remove the brick without damaging the surrounding wall.		
3	Mix the mortar to match existing.		
4	Replace the brick with care to ensure full joints and finished appearance to match existing.		
5	Housekeeping <ul style="list-style-type: none"> <li>• Leave work area clean and tidy.</li> <li>• Clean the area and replace tools and surplus resources.</li> <li>• Dispose of waste correctly (if applicable).</li> </ul>		

## Knowledge questions

- 1) What is the cause of spalling in a brick wall?
  - a Cracking.
  - b Acid attack.
  - c Moisture.
  - d Frost attack.
  
- 2) When preparing mortar for the repair which of the following is the **best** way?
  - a. Mechanical mixer.
  - b. Pre mixed bags.
  - c. Hand mixing.
  - d. Post mix.
  
- 3) When replacing a brick at height in a gable end which is the **best** method of accessing the work?
  - a. Ladder.
  - b. Scaffolding.
  - c. Trestles.
  - d. Steps.

<b>Task title:</b>	Remove a spalled brick from a wall and replace with a new one
<b>Candidate feedback</b>	
<b>Assessor feedback</b>	
<b>Action plan</b>	

### Task 3 Remove efflorescence from the face of a wall

<b>Candidate name</b>	
<b>Date</b>	

**Job details:** identify a wall that has suffered from staining by efflorescence. You will need to establish the cause, and select the correct tools and equipment to remove the efflorescence and if possible, prevent its return.

**Assessment methods:** you will be assessed on the way in which you identify the cause and the way in which you select the correct tools to remove the staining. You will also be assessed on the way in which you identify how to prevent the staining returning. You will be assessed by observation throughout the task and on the final outcome.

**Scope of content:**

- identify probable cause of staining
- remove the efflorescence
- seal the surface of the wall to prevent its return.

No	Candidate instructions	Achieved	
		Yes	No
1	Explain why the staining has appeared.		
2	Select the correct tools, materials and equipment to carry out the task.		
3	Remove the staining without damaging the surface.		
4	Treat the surface to seal the area.		
5	Housekeeping <ul style="list-style-type: none"> <li>• Leave work area clean and tidy.</li> <li>• Clean the area and replace tools and surplus resources.</li> <li>• Dispose of waste correctly (if applicable).</li> </ul>		

## Knowledge questions

1) Which tool is the **best** to use when removing efflorescence?

- a. Chisel.
- b. Brush.
- c. Scraper.
- d. Bolster.

2) How is efflorescence **best** described?

- a. Staining on the surface of a wall.
- b. Staining on the brickwork joints.
- c. Black staining on the wall surface.
- d. Salt deposits on the surface of a wall.

3) Which items of PPE **must** be worn when removing efflorescence?

- a. Eye protection, gloves and mask.
- b. Ear protection, gloves and mask.
- c. Ear protection, eye protection and gloves.
- d. Ear protection, mask and overalls.

<b>Task title:</b>	Remove efflorescence from the face of a wall
<b>Candidate feedback</b>	
<b>Assessor feedback</b>	
<b>Action plan</b>	

## Task 4 Remove and replace a defective wall tie

<b>Candidate name</b>	
<b>Date</b>	

**Job details:** remove a defective wall tie from a wall and replace it with a new one.

**Assessment methods:** you will be assessed on the way in which you approach the removal of the defective tie, tools selection, selection of materials and the finished work. You will be assessed by observation throughout the task and on the final outcome.

### Scope of content:

- remove a defective wall tie from a cavity wall
- replace with a new tie
- make good the face of the wall.

No	Candidate Instructions	Achieved	
		Yes	No
1	Select the correct materials to carry out the task.		
2	Select the correct tools and equipment to carry out the task.		
3	Remove the defective wall tie without causing excess damage.		
4	Select the materials to complete the repair.		
5	Replace the wall tie and make good the wall.		
6	Housekeeping <ul style="list-style-type: none"> <li>• Leave work area clean and tidy.</li> <li>• Clean the area and replace tools and surplus resources.</li> <li>• Dispose of waste correctly (if applicable).</li> </ul>		



## Knowledge questions

1) Which wall tie is the **most** durable?

- a. Steel.
- b. Galvanised.
- c. Stainless steel.
- d. Aluminium.

2) What is the **most** common cause of wall tie failure?

- a. Acid attack.
- b. Corrosion.
- c. Wear and tear.
- d. Mortar breakdown.

3) What is the **most** effective way of proving a replacement wall tie?

- a. Cutting out joints and re-bedding.
- b. Drilling and fixing.
- c. Nailing with an air gun.
- d. Fixing with lime mortar.

<b>Task title:</b>	Remove and replace a defective wall tie
<b>Candidate feedback</b>	
<b>Assessor feedback</b>	
<b>Action plan</b>	

## Task 5 Set out a segmental arch

<b>Candidate name</b>	
<b>Date</b>	

**Job details:** set out a segmental arch using a board or a flat level surface. See Figure 1.

**Assessment methods:** this task requires you to demonstrate your setting out skills. You will be assessed by observation throughout the task and on the final outcome.

### Scope of content:

- establish the setting out lines
- set out the span and rise of the arch
- position the bisecting line, and bisect it to establish the striking point
- draw the intrados and extrados of the arch
- establish the skewbacks
- traverse the extrados of the arch into equal voussoirs
- parallel the joint lines of the voussoirs
- produce a face template.

No.	Candidate instructions	Achieved	
		Yes	No
1	Select the correct tools, materials and equipment.		
2	Establish setting out line correctly.		
3	Establish span and rise correctly.		
4	Establish and bisect bisecting line correctly.		
5	Establish striking point.		
6	Draw intrados and extrados correctly.		
7	Draw skewbacks correctly.		
8	Traverse extrados of arch into equal voussoir sizes.		
9	Establish parallel joint lines correctly.		
10	Produce a face template.		
11	Housekeeping <ul style="list-style-type: none"> <li>• Leave work area clean and tidy.</li> <li>• Clean materials and store away correctly (if applicable).</li> <li>• Dispose of waste correctly (if applicable).</li> </ul>		

Figure 1 Set out segmental arch

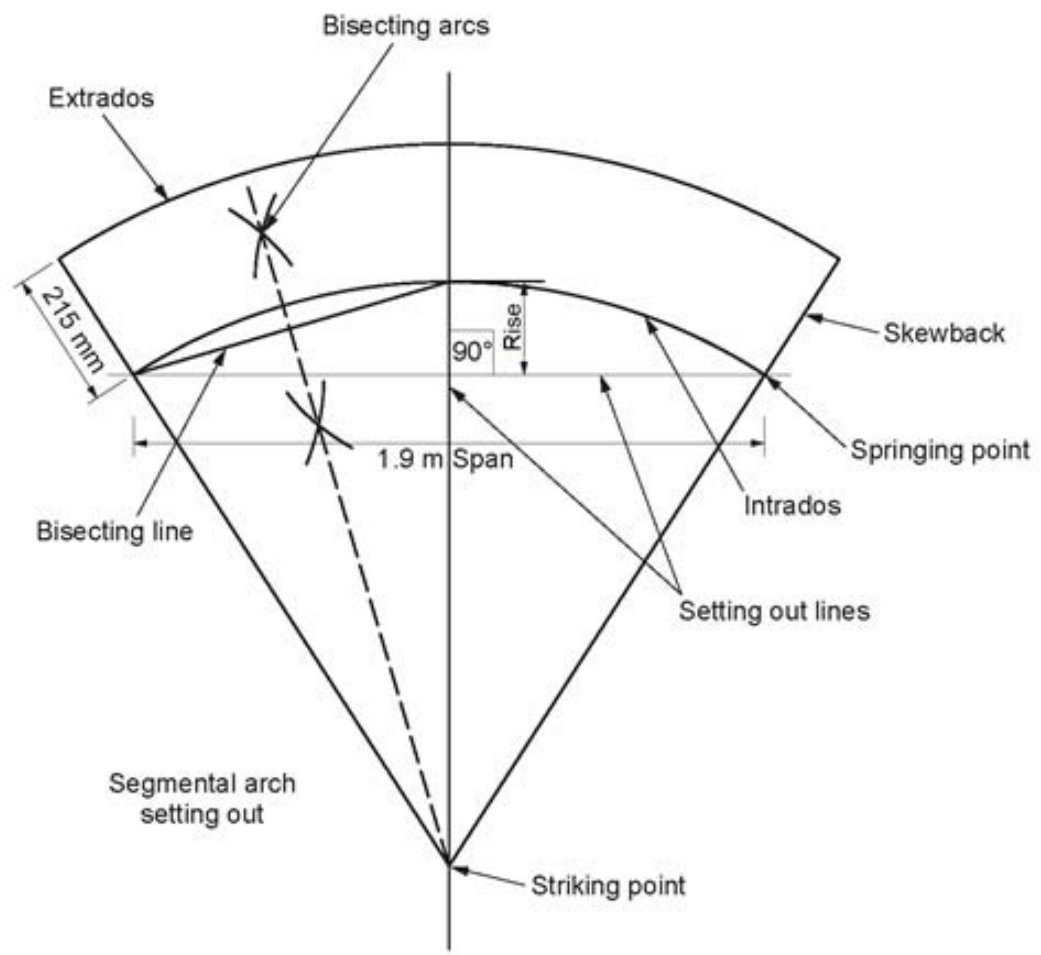

## Knowledge questions

- 1) Which item of equipment helps with removing the turning piece?
  - a. Straight edges.
  - b. Folding wedges.
  - c. Trammel heads.
  - d. Line and pins.
  
- 2) What is the **maximum** size for a voussoir joint?
  - a. 10 mm
  - b. 100 mm
  - c. 1000 mm
  - d. 1500 mm
  
- 3) Which operation is carried out in order to establish the voussoir size on the extrados?
  - a. Tapping down.
  - b. Traversing.
  - c. Tapering off.
  - d. Travelling.

<b>Task title:</b>	Set out a segmental arch
--------------------	--------------------------

**Candidate feedback**

**Assessor feedback**

**Action plan**

## Task 6 Set out and build curves of a different radius

<b>Candidate name</b>	
<b>Date</b>	

**Job details:** set out two different radiuses in readiness for building a half brick thick wall.

**Assessment methods:** this task requires you to demonstrate your practical and setting out skills. You will be assessed by observation throughout the task and on the final outcome.

### Scope of content:

- set out convex and concave curves to the radiuses shown in Figures 1 and 2
- establish the face line on a flat level surface
- set out a half brick thick wall to drawing dimensions as shown in Figure 3
- mark out and make convex and concave templates
- build walls using the templates produced.

No	Candidate Instructions	Achieved	
		Yes	No
1	Select the correct tools, materials and equipment.		
2	Set out and mark all curves correctly.		
3	Establish the correct radius measurements.		
4	Set out brickwork to correct bond, and mark perp positions.		
5	Cut all brick cuts accurately.		
6	Build a concave wall, using template correctly.		
7	Build a convex wall, using template correctly.		
8	Gauge correctly.		
9	Level correctly.		
10	Plumbing point 1 correct.		
11	Plumbing point 2 correct.		
12	Plumbing point 3 correct.		
13	Plumbing point 4 correct.		
14	All joints full and complete.		
15	Face joints to a half round finish.		
16	Housekeeping <ul style="list-style-type: none"> <li>• Leave work area clean and tidy.</li> <li>• Clean materials and store away correctly (if applicable).</li> <li>• Dispose of waste correctly (if applicable).</li> </ul>		

Figure 1

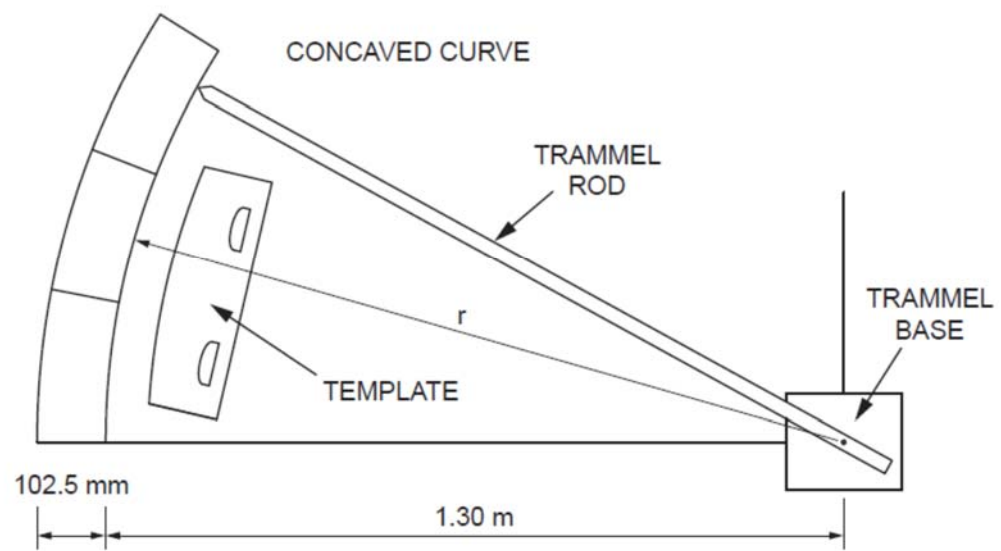

Figure 2

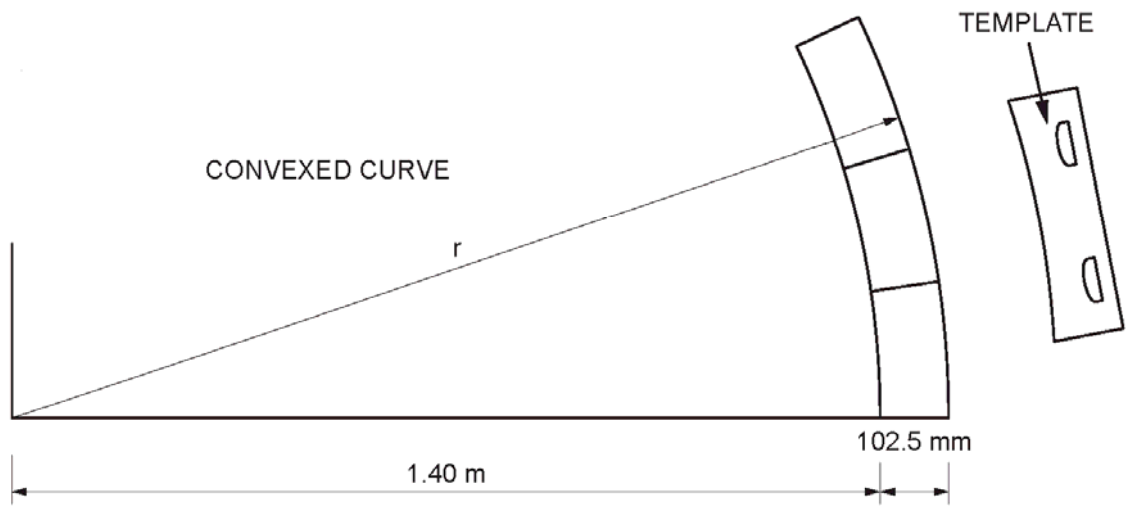
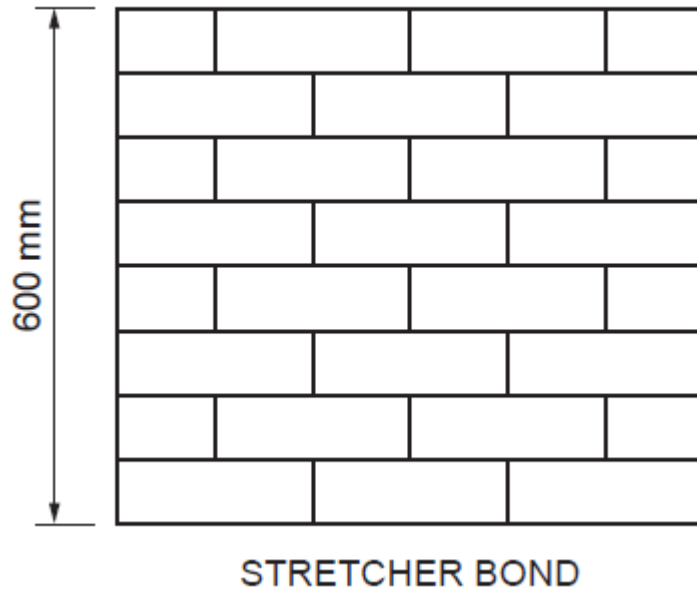



Figure 3



## Knowledge questions

1) Which size radius would provide a more regular 10 mm perp joint?

- a. 0.6 m
- b. 0.9 m
- c. 1.0 m
- d. 1.5 m

2) Which item of equipment would be used to set out curved walling?

- a. Trammel heads.
- b. String line.
- c. Gauge rod.
- d. Spirit level.

3) Which of the following statements is correct when working out the radius?

- a. The radius is twice the diameter.
- b. The radius is half the diameter.
- c. The radius is half of the perimeter.
- d. The radius is twice the perimeter.

**Task title:**

Set out and build curves of a different radius

**Candidate feedback**

**Assessor feedback**

**Action plan**

**Task 7** Build an English bond wall with a battered face

<b>Candidate name</b>	
<b>Date</b>	

**Job details:** build a small English bond retaining wall with a battered face. See Figure 1.

**Assessment methods:** this task requires you to demonstrate your practical and setting out skills. You will be assessed by observation throughout the task and on the final outcome.

**Scope of content:**

- set up batter boards and supports
- dry bond the wall
- build wall to a batter.

No.	Candidate instructions	Achieved	
		Yes	No
1	Select the correct tools, materials and equipment.		
2	Set up batter boards correctly.		
3	Set out and mark bond correctly.		
4	Maintain bond.		
5	Ensure all cuts are correct size.		
6	Gauge wall correctly.		
7	Level wall correctly.		
8	All joints are full and complete.		
9	Face joints to a half round finish.		
10	Housekeeping <ul style="list-style-type: none"> <li>• Leave work area clean and tidy.</li> <li>• Clean materials and store away correctly (if applicable).</li> <li>• Dispose of waste correctly (if applicable).</li> </ul>		

**Figure 1 English bond wall with a battered face**

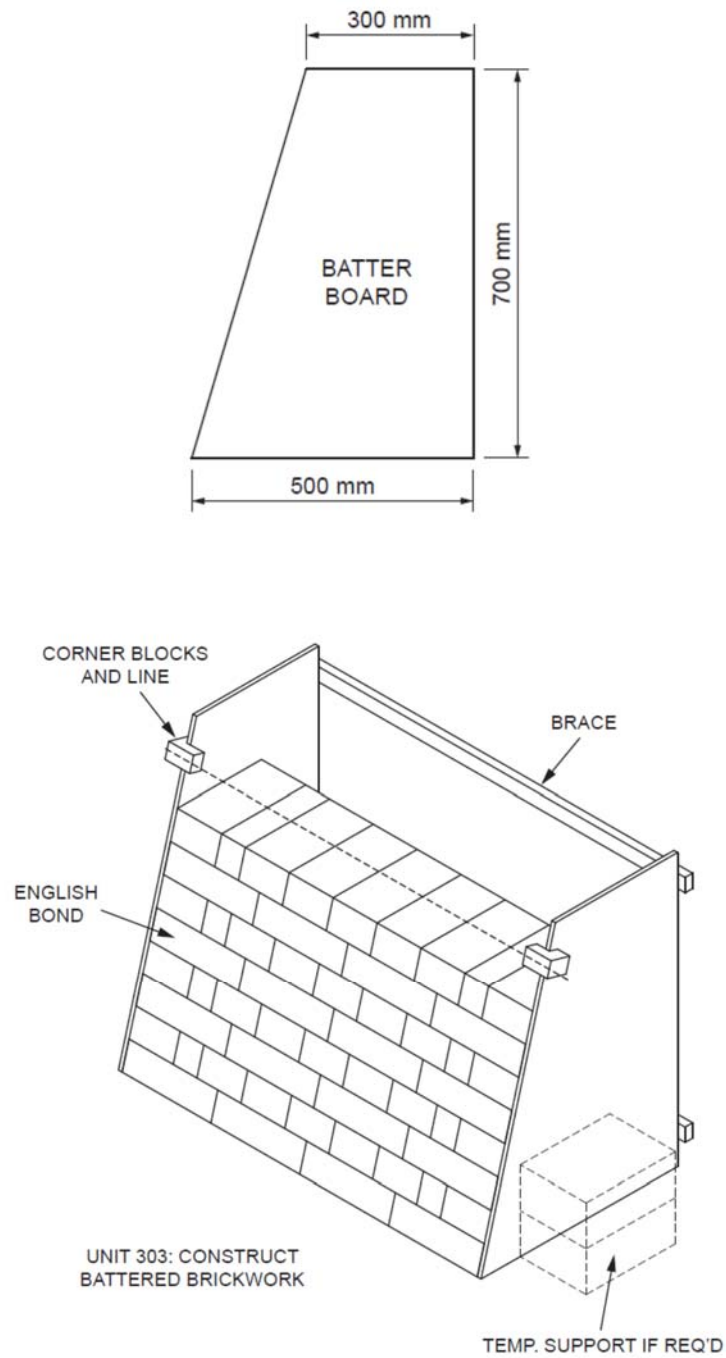

## Knowledge questions

1) How many courses are required to dry bond English bond?

- a. 1
- b. 2
- c. 3
- d. 4

2) What is the **minimum** thickness of a one brick thick wall?

- a. 200 mm
- b. 215 mm
- c. 230 mm
- d. 245 mm

3) Which cut brick is required to form English bond?

- a. King closer.
- b. Bevelled closer.
- c. Queen closer.
- d. Bat closer.

**Task title:**

Build an English bond wall with a battered face

**Candidate feedback**

**Assessor feedback**

**Action plan**

**Task 8** Set out and build a decorative panel with features

<b>Candidate name</b>	
<b>Date</b>	

**Job details:** set out and build a horizontal basket weave panel with decorative features and reinforcement. See Figure 1.

**Assessment method:** this task requires you to demonstrate your practical and setting out skills. You will be assessed by observation throughout the task and on the final outcome.

**Scope of content:**

- set out and build a decorative reinforced panel with decorative features.

No.	Candidate instructions	Achieved	
		Yes	No
1	Select the correct tools, materials and equipment.		
2	Set out the panel to the correct size.		
3	Maintain gauge.		
4	Level plinth bricks.		
5	Plumb soldier bricks.		
6	Maintain plumb to abutments.		
7	Bond correctly.		
8	Level and plumb to panel abutments.		
9	Maintain the range in-between the panel and abutments.		
10	Maintain uniform joint thickness at 10 mm.		
11	Joint finish to inside of panel to be recessed.		
12	Joint finish to wall to be half round.		
13	Bond dentil course correctly including 20 mm oversail.		
14	Install reinforcement correctly.		
15	Housekeeping <ul style="list-style-type: none"> <li>• Leave work area clean and tidy.</li> <li>• Clean materials and store away correctly (if applicable).</li> <li>• Dispose of waste correctly (if applicable).</li> </ul>		



**Figure 1 A horizontal basket weave panel with decorative features**

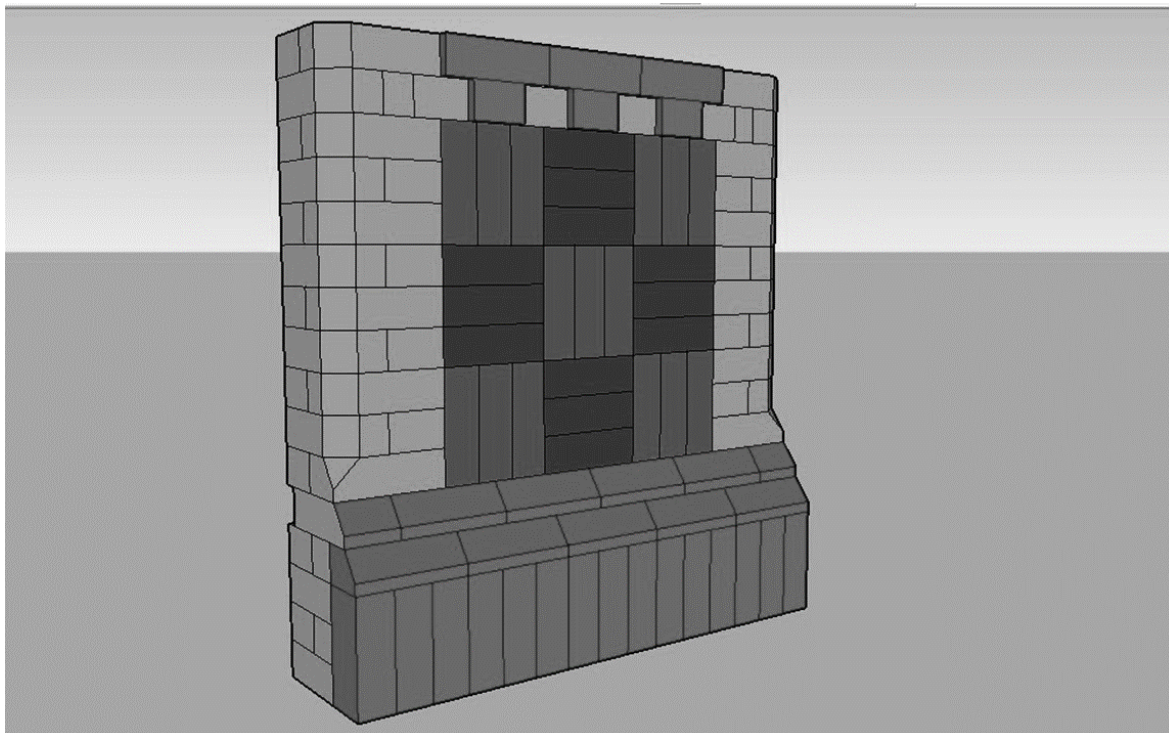
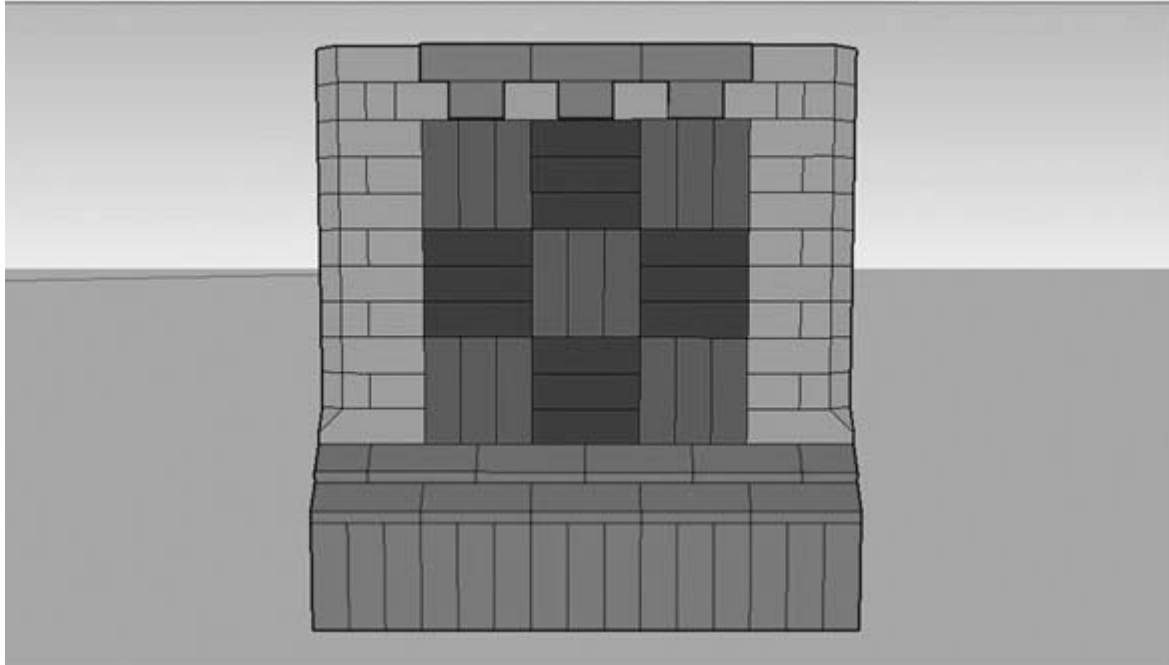

## Knowledge questions

1) Identify the special brick shown in Figure 2.

- a. Plinth.
- b. Cant.
- c. Radial.
- d. Bullnose.

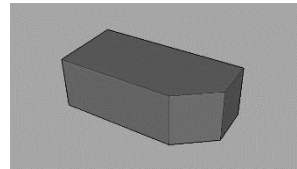

**Figure 2**

2) Identify the decorative feature shown in Figure 3.

- a. Dentil course.
- b. Basket weave.
- c. Dog-toothing.
- d. Plint course.

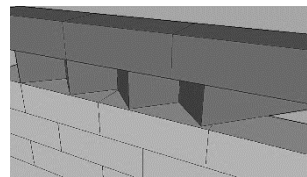

**Figure 3**

3) What would be the angle for a diagonal Herringbone panel?

- a. 45°
- b. 90°
- c. 145°
- d. 180°

**Task title:**

Set out and build a decorative panel with features

**Candidate feedback**

**Assessor feedback**

**Action plan**

## Task 9 Set out and build an obtuse quoin

<b>Candidate name</b>	
<b>Date</b>	

**Job details:** set out and build an obtuse quoin in Flemish bond. See Figure 1.

**Assessment methods:** this task requires you to demonstrate your practical and setting out skills. You will be assessed by observation throughout the task and on the final outcome.

### Scope of content

- set out and build an obtuse quoin in Flemish bond.

No	Candidate instructions	Achieved	
		Yes	No
1	Select the correct tools, materials and equipment.		
2	Set out the quoin to the correct angle.		
3	Dry bond the first two courses.		
4	Maintain Flemish bond.		
5	Maintain gauge.		
6	Level brick on edge.		
7	Maintain plumb.		
8	Maintain the range to the face side of the wall.		
9	Mitre Brick on Edge correctly.		
10	Cut brick evenly to the mitre.		
11	Bond correctly.		
12	Joint finish to be recessed.		
13	Housekeeping <ul style="list-style-type: none"> <li>• Leave work area clean and tidy.</li> <li>• Clean materials and store away correctly (if applicable).</li> <li>• Dispose of waste correctly (if applicable).</li> </ul>		

**Figure 1 An obtuse quion**

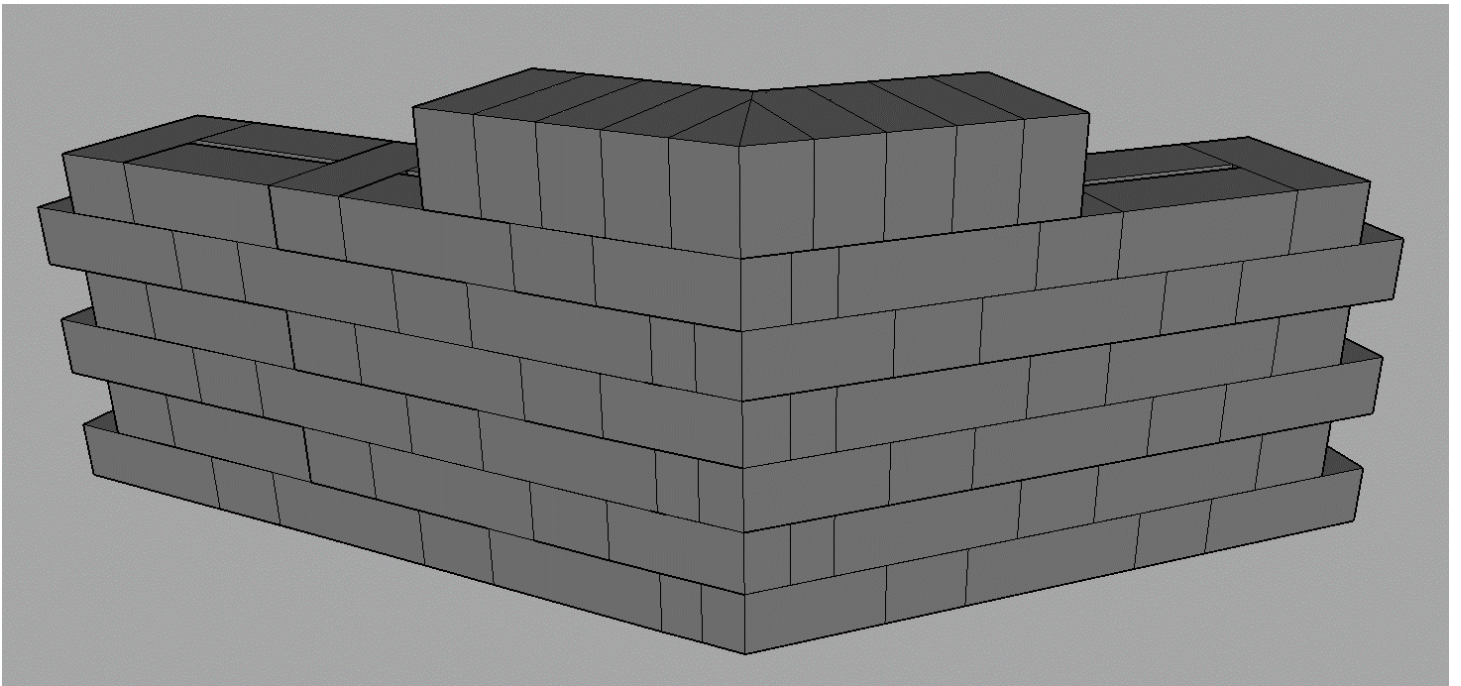

## Knowledge questions

1) What type of brick is used on an obtuse quoin?

- a. Plinth.
- b. Bullnose.
- c. Radial.
- d. Squint.

2) When setting out, what do the angles of a triangle add up to?

- a.  $45^\circ$
- b.  $90^\circ$
- c.  $180^\circ$
- d.  $360^\circ$

3) Quoins that are set out on plan at an angle **less** than  $90^\circ$  are known as

- a. obtuse.
- b. acute.
- c. right.
- d. reflex.

**Task title:**

Set out and build an obtuse quoin

**Candidate feedback**

**Assessor feedback**

**Action plan**

## ASSESSOR GUIDANCE

These practice tasks are designed for the candidates to make use of the 'tool kit' of knowledge, understanding and skills they will gain during their teaching and learning during this qualification in order to tackle problems/ tasks/ challenges.

Candidates are provided with a set of tasks, which can be taken in any order. The candidates have to reach into their knowledge and skills to independently select the correct processes, skills, materials, approaches to take etc, drawing on the full range of knowledge and understanding from across the qualification to make good decisions that will achieve an end result that is fit for the specified purpose.

These formative tasks will allow candidates to be supported in learning how to independently use the learning they have covered so far, drawing this together in a similar way, so they are familiar with the format, conditions and expectations of the practical assignment that they will sit at the end of this qualification.

Tutors have the option of asking candidates to complete a risk assessment, method statement or resource checklist, but this is not compulsory. Generic forms for these can be found in the appendix section.



## Guidance on tasks

### Resources

Centres will have well equipped workshops with compressive range of hand and portable power tools that meet current industry standards. All powered equipment should be well maintained and PAT certified. Centres will have special designated areas within their workshop (cubicles or project area) allowing candidates to practice the requirements of the unit and practice tasks.

### Health and safety

Candidates should not be entered for assessment without being clear of the importance of working safely, and practice of doing so. The tutor must immediately stop a task if a candidate works unsafely and give the candidate feedback on why they were stopped.

Where it is appropriate candidates must be supervised when operating machinery.

### Observation

Candidates must be observed carrying out these practice tasks and notes must be taken on the quality of performance along with any other aspect of performance that will support giving feedback to the candidate.

### Preparation

During the formative practice tasks, tutors should routinely point out good or poor performance during the learning period, and through formative assessment. Candidates should be encouraged to do the best they can and be made aware of the difference between these formative assessments and the summative assessments.

## Answer keys

**Task 1** Remove and replace a defective lintel over a door opening

Question	Correct key
1	B
2	C
3	C

**Task 2** Remove a spalled brick from a wall and replace with a new one

Question	Correct key
1	D
2	C
3	B

## Unit 302 Practice task 2 – guidance on practical task

1i and 2i Provide sketches or insert images of the tools, equipment and materials that you will need to carry out the work.

### Tools



Chisel



Lump Hammer



Trowel



Spirit level

**Equipment**



Barriers



Strongboy

**Materials**



Concrete lintel



Mortar

**3i** Explain how you will support the brickwork over the opening to allow you to remove the existing lintel.

Answer to include/indicative content: using a jointing chisel, remove the bed joints immediately above the defective lintel to allow the strongboys to be positioned to support the load above.



## 5 Remove lintel

Once the defective lintel is removed, candidates will need to prepare the bearing to receive the new lintel.



## 6 Replace Lintel

When the new lintel is in position, candidates should fill the joints above the lintel to ensure that it is able to support the load.



## Candidate instructions

### 1. Select the correct materials to carry out the task

Ensure the candidate select the correct type and colour of brick so that it matches the existing.

### 2. Select the correct tools and equipment to carry out the task

Ensure the candidate has selected the correct tools and equipment to carry out the task.

**Note to tutor:** please ensure that the candidate has correctly selected the materials to match the existing, ensuring that the colour of the brick and mortar provide a good match for the original materials.

### Task 3 Remove efflorescence from the face of a wall

Question	Correct key
1	B
2	D
3	A

### Task 4 Remove and replace a defective wall tie

Question	Correct key
1	C
2	B
3	B

### Task 5 Set out a segmental arch

Question	Correct key
1	B
2	A
3	B

### Task 6 Set out and build curves of a different radius

Question	Correct key
1	D
2	A
3	B

**Task 7** Build an English bond wall with a battered face

Question	Correct key
1	B
2	B
3	C

**Task 8** Set out and build a decorative panel with features

Question	Correct key
1	B
2	C
3	A

**Task 9** Set out and build an obtuse quoin

Question	Correct key
1	D
2	C
3	B





<b>Materials</b>	<b>Quantity</b>
<i>eg paving slabs</i>	<i>10</i>

<b>Personal Protective Equipment (PPE)</b>	<b>Quantity</b>
<i>eg safety harness</i>	<i>1</i>

# Risk assessment form



<b>Candidate Name</b>	<b>SEVERITY (S):</b> Degree of harm which may be caused (including numbers affected) 1 = Minor Injury 2 = Major Injury 3 = Fatality	<b>LIKELIHOOD (L):</b> Probability that event will occur 1 = Remote 2 = Possible 3 = Likely	<b>RISK RATING (RR):</b> Severity x Likelihood 1-2 = Low 3-4 = Medium 6-9 = High
-----------------------	---	---	--

Date	Task title	Hazard	Existing Controls	S (1-3)	L (1-3)	RR (S x L)	Actions needed
18 July 2013	Apply materials and fix tiles to surfaces	Chemical based adhesives	PPE	1	2	2	Implement sign off sheet to ensure PPE is worn

Task title	Hazard	Existing Controls	S (1-3)	L (1-3)	RR (S x L)	Actions needed

		Likelihood		
		Unlikely	Possible	Very likely
Severity	1 Slight / minor injuries / minor damage	1	2	3
	2 Medium injuries / significant damage	2	4	6
	3 Major injury / extensive damage	3	6	9

#### Likelihood

3 = Very likely

2 = Possible

1 = Unlikely

#### Severity

3 = Major injury / extensive damage

2 = Medium injury / significant damage

1 = Slight / minor damage

#### Key:















1 = Low risk, action should be taken to reduce the risk if reasonably practicable

2, 3, 4 = Medium risk, is a significant risk and would require an appropriate level of control measures

6 & 9 = High risk, should not be undertaken without prior agreement

# Method statement

<b>Department/ location:</b>		
<b>Risk assessment no.</b>		
<b>Description of the task/ activity:</b>		
<b>Personnel involved:</b>	<b>Name</b>	<b>Role/ trade</b>
<b>Key plant &amp; tools:</b>		
<b>Key materials:</b>		
<b>Other essential equipment: (ie access platforms/ winches/ ladders, etc.)</b>		
<b>Specific identified residual hazards: (or refer to the task specific risk assessment(s))</b>		
<b>Specific staff training:</b>		
<b>Sequence of operations: (include sketches if required)</b>		

<b>Hazardous substances:</b> (attach MSDS if required)  <b>Applicable:</b>							
	Very toxic	Harmful/irritant	Corrosive	Dangerous for the environment	Oxidising	Highly flammable	Explosives
<b>Required Personal Protective Equipment:</b>							
	Safety boots	Hard hats	Safety gloves	Hearing protection	Eye protection	Respiratory protection	Hi viz protective clothing
<b>Emergency procedures:</b>							
	<b>First Aid facilities:</b>	<b>Name of on-site First Aider:</b>					
		<b>First Aid box location:</b>					
		<b>Location of nearest hospital:</b>					
<b>Other information &amp; comments</b>							

# Declaration of Authenticity

Candidate name

Candidate number

---

Centre name

---

Centre number

---

## Candidate:

**I confirm that all work submitted for this synoptic assignment is my own, and that I have acknowledged all sources I have used.**

Candidate signature

Date

## Tutor:

**I confirm that all work was conducted under conditions designed to assure the authenticity of the candidate's work, and am satisfied that, to the best of my knowledge, the work produced is solely that of the candidate.**

---

Tutor signature

Date

## Assessment feedback form

Candidate name

Candidate number

Assessor name

Date of assessment

Task / AO	Feedback

Assessor signature and date: